

#### 温馨提示:

- 1、安装本产品之前需要仔细冲洗管道,确保管道里面不存留金属屑、焊接后的残渣或麻丝,或者是其他脏物。也会通过水管进入装置,从而影响产品的密封性能。
- 2、建议产品开孔尺寸  
龙头:  $\varnothing 35$   
把手:  $\varnothing 33$

#### 尊敬的用户:

真诚的感谢您选择琅瑞卫浴产品,为了保障您的权益,请您完整了解以下保修条款:

- 1、用户凭保修卡和产品购买时的发票或收据(复印件无效)在三年保修期内享受免费保修服务;
- 2、属以下情况范围,免费保修失效。
  - a、超过保修期或无保修卡及购货凭证的;
  - b、未按产品说明书安装使用和保养或在不符合产品说明书规定的使用环境下使用而造成的故障;
  - c、使用具有腐蚀性(含丙酮或氨水成份)洗涤剂或含甲酸甲醛的消毒剂而引起的产品故障或部件损坏;
  - d、使用不适当的电源情况(如用电系统未能良好接地,电压过高过低等)而引起的产品故障或部件损坏;
  - e、因自然灾害等不可抗力(如地震、火灾等)以及其他意外因素(碰撞、砸烂、踩压等)而引起的产品故障或部件损坏。







## 水龙头安装和使用





## Faucet installation and use

## Precautions





### English

 Please refer to the installation instructions in this chapter	<b>Technical data</b>	
 request visual inspection (e.g. check for scratches)	Operating pressure	The biggest 0.8 MPa
 Ask to check for tightness	advice	less than 0.5 MPa
 Please wear gloves	Test pressure	high pressure 1.6 Mpa. Medium pressure 0.5Mpa Low pressure 0.05Mpa
		1 MPa = 10 bar = 145 PSI
	Hot water temperature	Highest 65°C

### Italiano

 Si prega di fare riferimento all'installazione istruzioni in questo capitolo	<b>Dati tecnici</b>	
 Richiesta di ispezione visiva (ad es. per cercare graffi)	Pressione di esercizio	Il più grande 0.8 MPa
 Chiedi di verificare la tenuta	consigli	meno di 0.5 MPa
 Si prega di indossare i guanti	Pressione di prova	alta pressione 1.6 Mpa. Media pressione 0.5Mpa Bassa pressione 0.05Mpa
		1 MPa = 10 bar = 145 PSI
	Temperatura dell'acqua calda	Massimo 65°C

### Español





 Consulte las instrucciones de instalación de este capítulo.	<b>Datos técnicos</b>	
 solicitar inspección visual (p. ej., comprobar si hay arañazos)	Presión operacional	máximo 0.8 MPa
 Pida comprobar la estanqueidad	Consejo	menos que 0.5 MPa
 Por favor use guantes	Presión de prueba	alta presión 1.6 Mpa. Media presión 0.5Mpa Baja presión 0.05Mpa
		1 MPa = 10 bar = 145 PSI
	Temperatura del agua caliente	Más alto 65°C

## Precautions





### Deutsch

 Bitte beachten Sie die Installationshinweise in diesem Kapitel	<b>Technische Daten</b>	
 Sichtprüfung anfordern (z.B. auf Kratzer prüfen)	Betriebsdruck	maximal 0.8 MPa
 Bitte um Dichtheitsprüfung	Vorschlagen	less than 0.5 MPa
 Handschuhe anziehen	Druck erkennen	hoher Druck 1.6 Mpa. Mitteldruck 0.5Mpa Niedriger Druck 0.05Mpa
		1 MPa = 10 bar = 145 PSI
	Warmwassertemperatur	Höchste 65°C

### Français

 Veuillez vous référer à l'installation instructions dans ce chapitre	<b>Données techniques</b>	
 demander une inspection visuelle (par exemple, vérifier les rayures)	Pression de service	Le plus grand 0.8 MPa
 Demandez à vérifier l'étanchéité	Conseil	moins que 0.5 MPa
 Veuillez porter des gants	Test de pression	haute pression 1.6 Mpa. Moyenne pression 0.5Mpa Basse pression 0.05Mpa
		1 MPa = 10 bar = 145 PSI
	Température de l'eau chaude	Plus haut 65°C

### Русский

 Данная глава ссылается на инструкцию по монтажу	<b>Технические данные</b>	
 Требуется осмотр (например, наличие царапин)	рабочее давление	максимум 0.8 MPa
 Требуется проверить герметичность	Предложить	меньше, чем 0.5 MPa
 Обязательно носить перчатки	Presión de prueba	высокое давление 1.6 Mpa. среднее давление 0.5Mpa низкое давление 0.05Mpa
		1 MPa = 10 bar = 145 PSI
	температура горячей воды	Самый высокий 65°C

# Precautions

## عربي

### البيانات التقنية

يشير إلى تنبيه  
حول التركيب في هذا الفصل



بحد أقصى 0.5 ميغا باسكال

ضغط التشغيل

0.3 ميغا باسكال

الموصى به

طلب معاينة  
(مثلًا بحثًا عن أية خدوش)



0.5 ميغا باسكال

ضغط الفحص

طلب فحص للتأكد من الإحكام



1 ميغا باسكال = 10 بار = 145 بوصة مربعة/رطل

طلب ارتداء قفازات



درجة حرارة الماء الساخن بحد أقصى 65 °م

## Português



Referência às instruções  
de montagem neste  
capítulo

### Dados técnicos

Pressão operacional

máximo 0.8 MPa



Solicitação para inspeção visual  
(por ex. quanto a arranhões)

Recomendado

Menor que 0.5 MPa



Solicitação para verificar quanto  
à estanqueidade

Pressão de ensaio

alta pressão 1.6 Mpa.  
pressão média 0.5Mpa  
pressão baixa 0.05Mpa



Solicitação para usar luvas

1 MPa = 10 bar = 145 PSI

temperatura da água quente

Altíssima 65°C

## 中文



请参阅本章中的安装说明

技术数据

运行压力

最大 0.8 MPa



要求目视检查  
(例如: 检查划痕)

建议

少于 0.5 MPa



要求检查密闭性

检测压力

高压 1.6 Mpa  
中压 0.5 Mpa  
低压 0.05 Mpa



要求戴手套

1 MPa = 10 bar = 145 PSI

热水温度

最高 65°C

## INHALTSVERZEICHNIS

Product Size — — — — — 1-2

Product List — — — — — 3

Installation method — — — — — 4-5

Method of use — — — — — 5

Maintenance and cleaning — — — — — 6

# Product Size

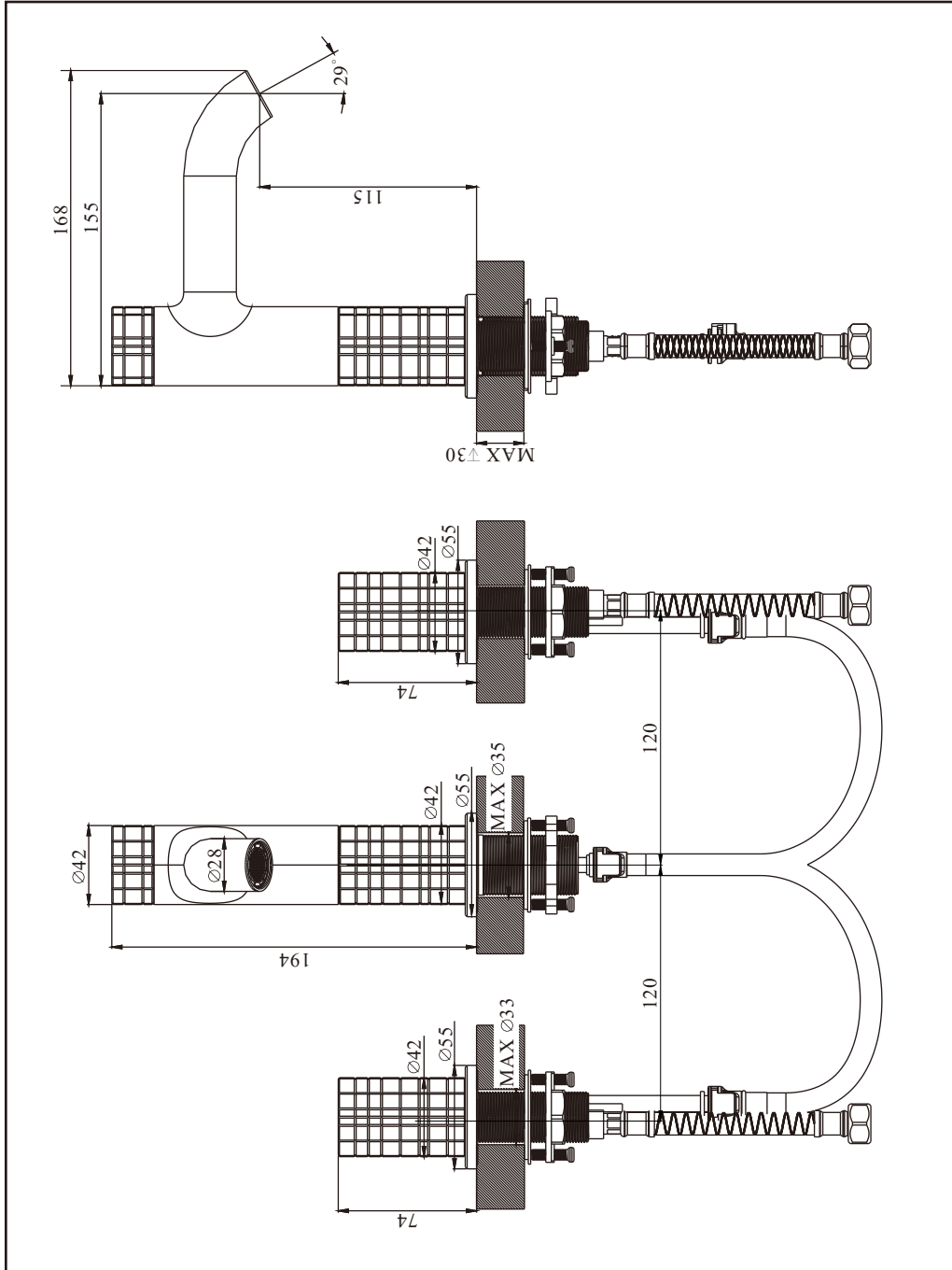

# Product Size

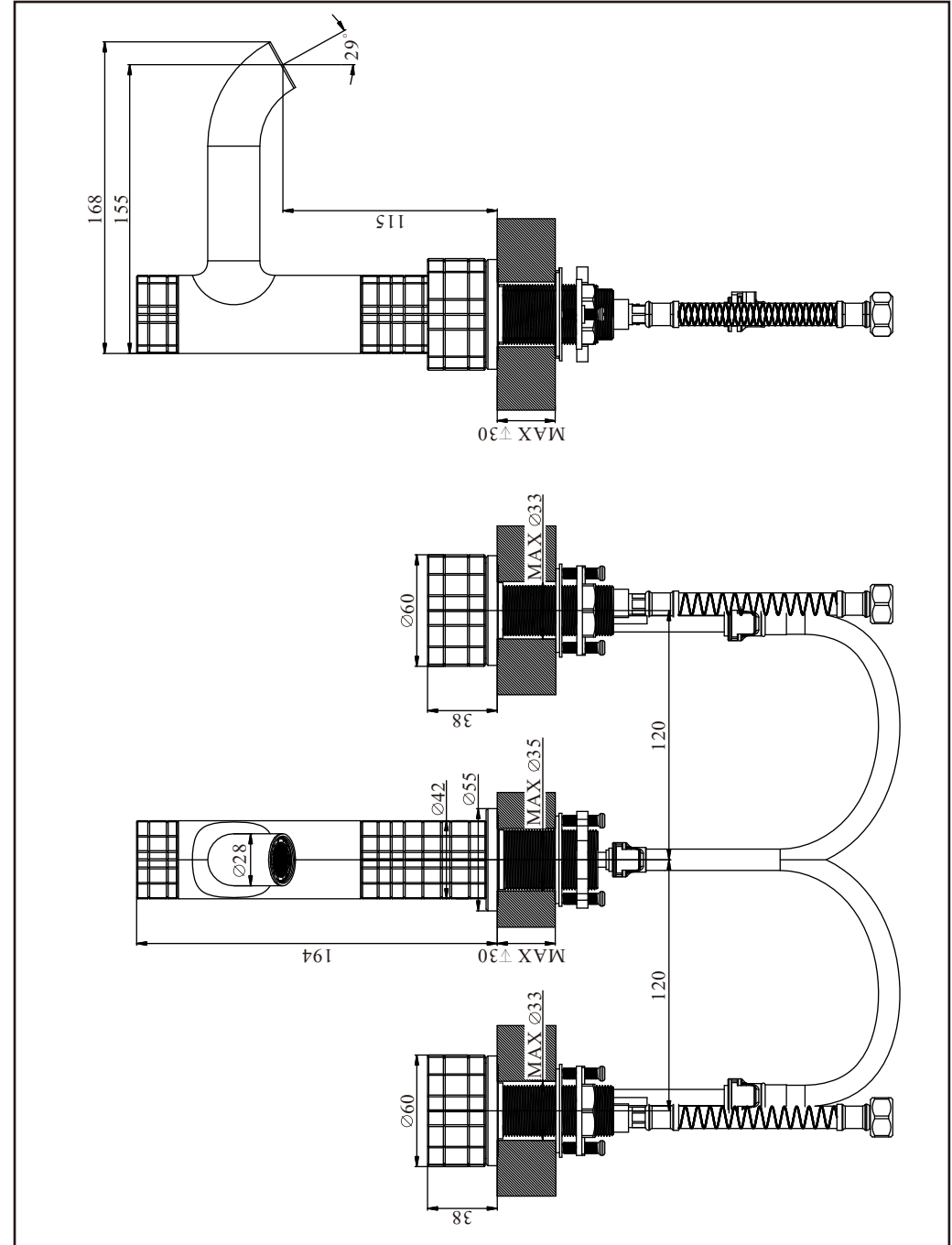

## Product List

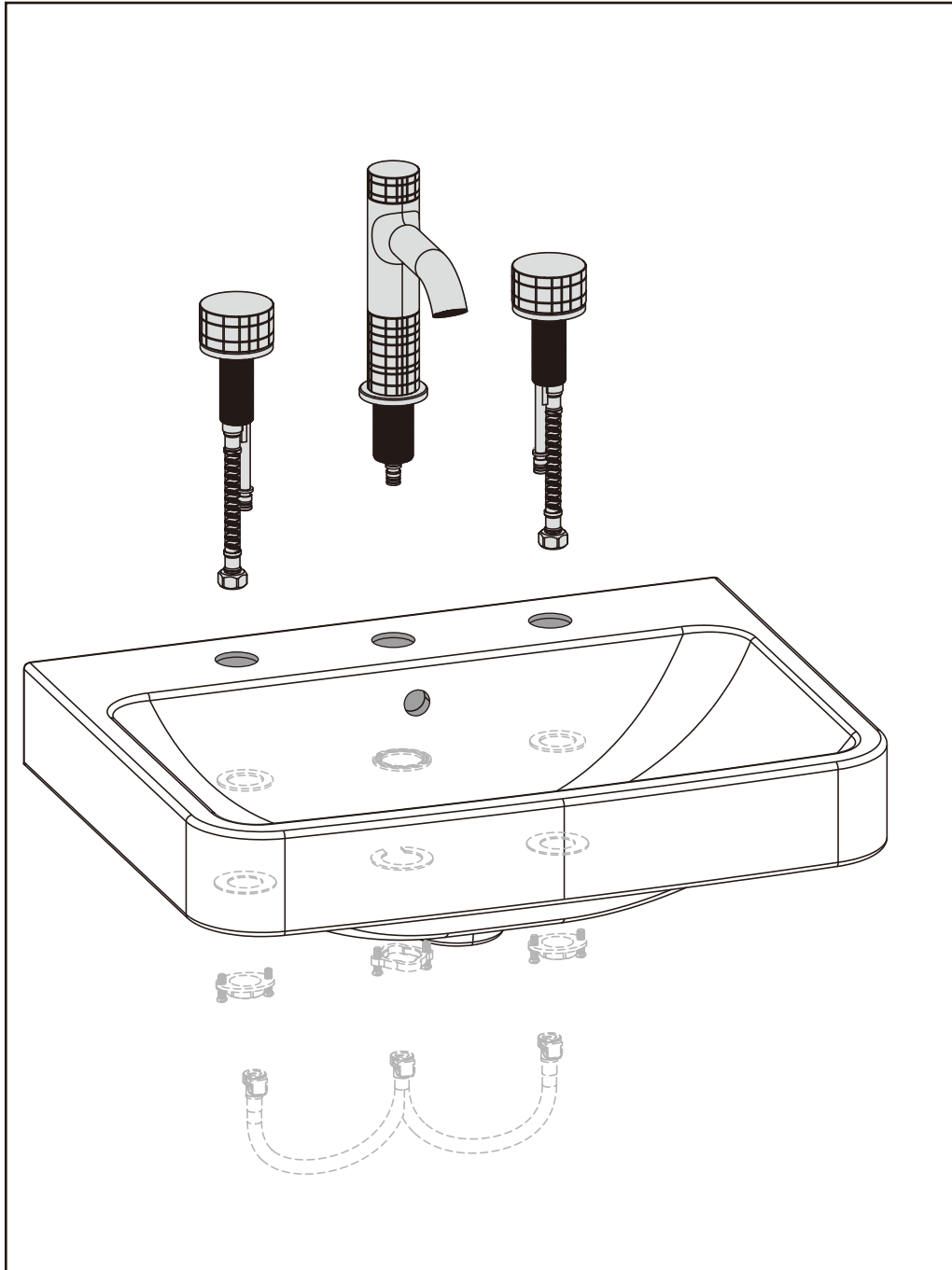

3

## Installation method

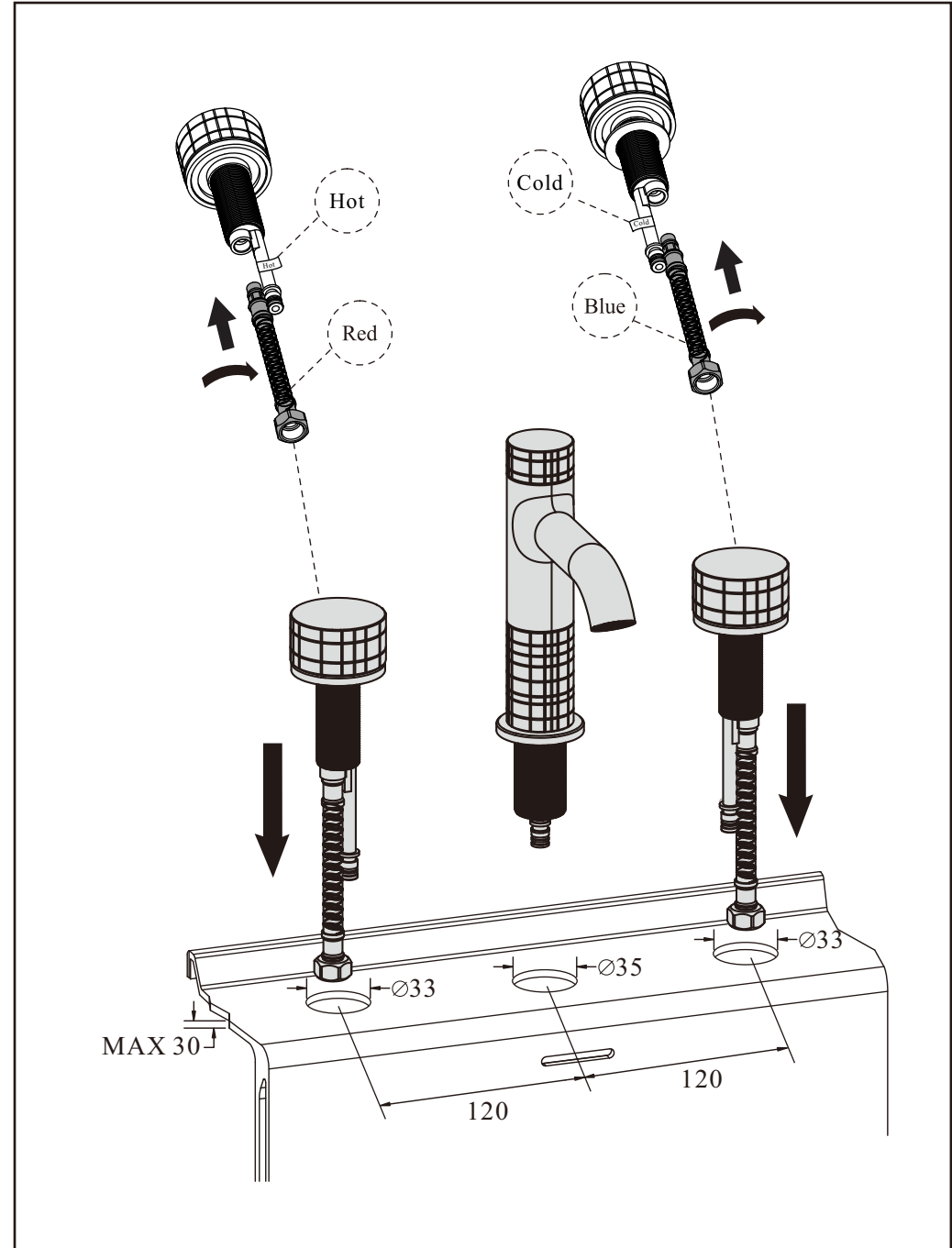

4

## Installation method

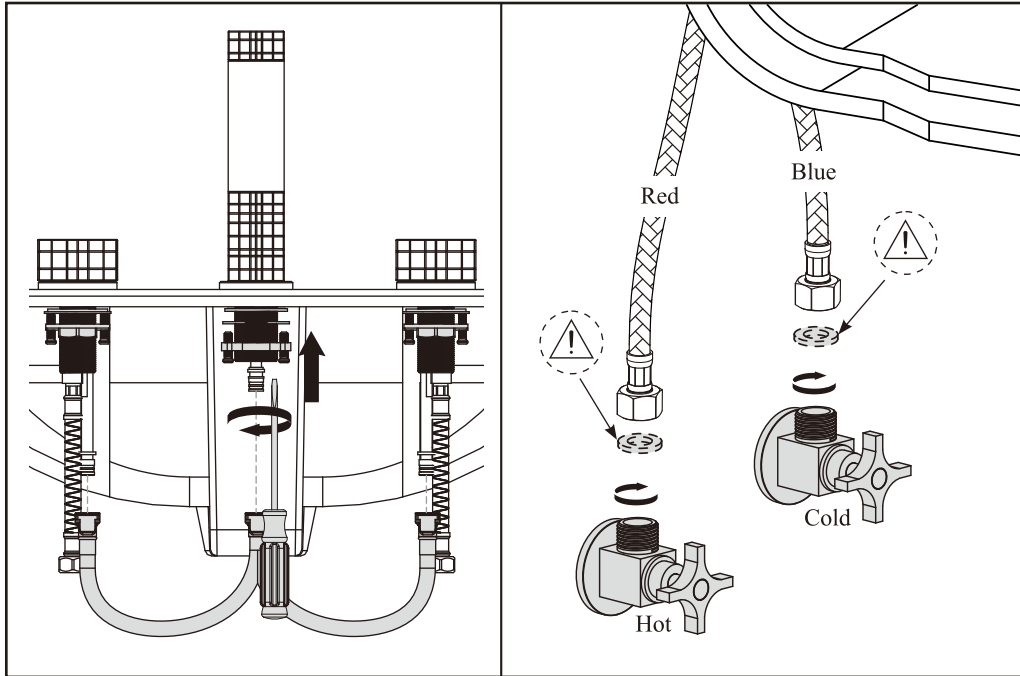

## Method of use

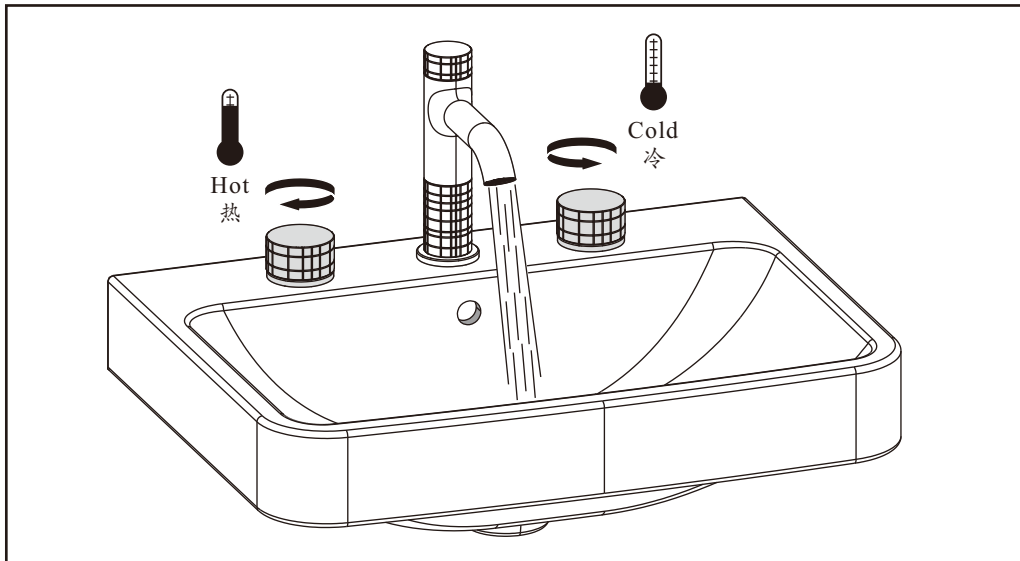

5

## Maintenance and cleaning

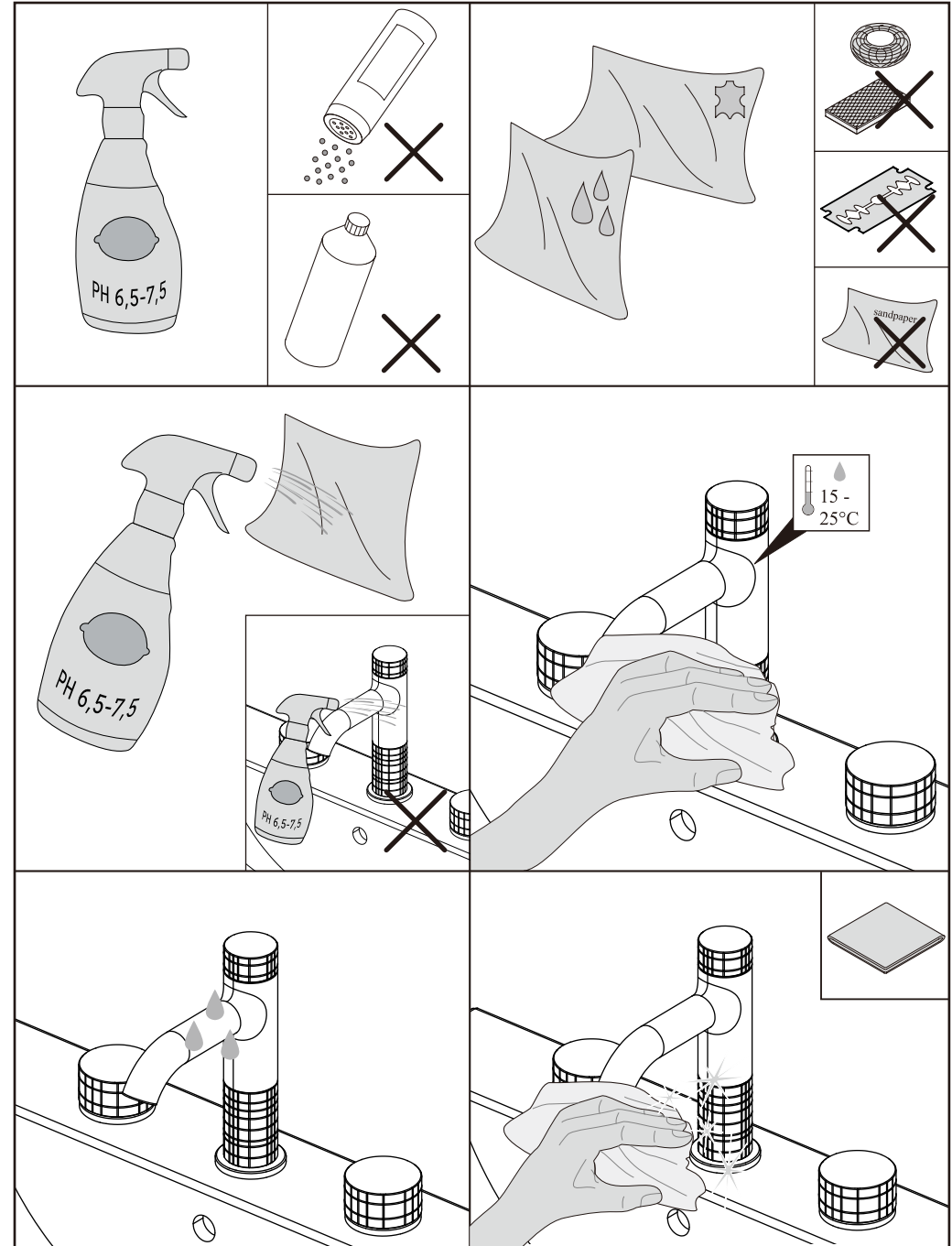

6